

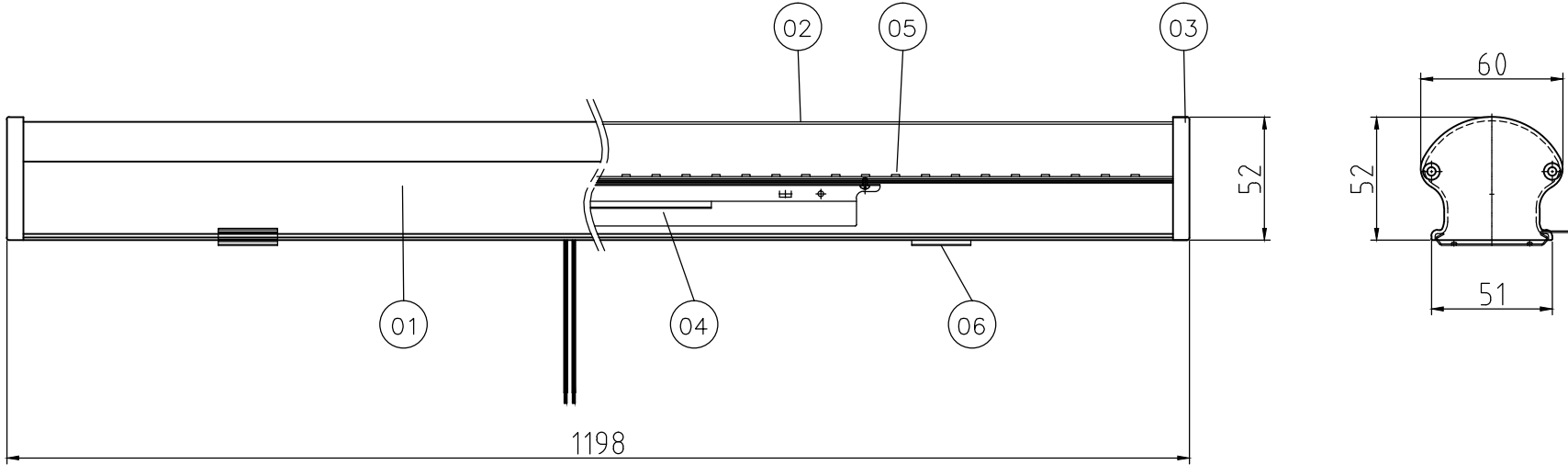

NO	NAME OF PLATE	Material	Q'TY	REMARK
01	Body Frame	A6063-T5	1	
02	Diffusion Cover	PC	1	
03	Side Cap	PBT	2	
04	Converter	SPCC	1	
05	LED Module	FR4-1T	1	
06	Snap Bracket	SUS304	2	



Specifications	
Power Consumption	50 W
Input Voltage	220 V
Input Current	0.23 A
Total Luminous Flux	5,500 lm
Color Temperature	5,700 K
Weight	0.8 Kg

PROJECT TITLE			
TITLE	LED CEILING LIGHT ASS'Y (K-LINE 1200 x 50W)	DATE	2020. 09. 02
MODEL NO	FKL12D5057-S-01	SCALE	1/1
DSND BY: Lee Kwangseok	DRAWN BY:	CHKD BY: Park Jaehwal	APRVD BY:
		D.W.G. NO. FKL-12D50-S-001A	REVISION. 00