

NO	NAME OF PLATE	Material	Q'TY	REMARK
01	Body Case	SPCC	1	
02	Diffusion Cover	PP	1	
03	Hinge Bracket	SM45C	2	
04	Spring	SHW2	2	
05	LED Module	AL-1.5T	1	
06	Converter	PC	1	

-Perforation Size-

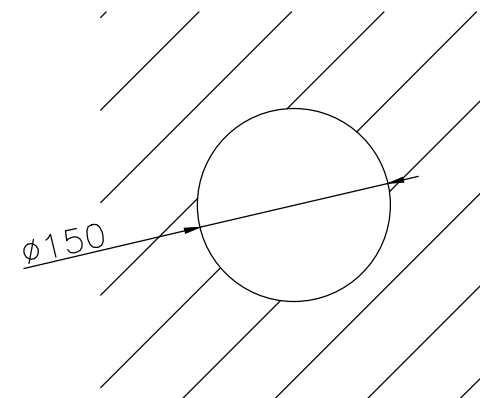

Specifications

Power Consumption	12 W
Input Voltage	220 V
Input Current	0.06 A
Total Luminous Flux	1,260 lm
Color Temperature	5,700 K
Weight	0.35 Kg

PROJECT TITLE			
TITLE	6inch Down Light Ass'y	DATE	2020. 09. 02
MODEL NO	FDL06L1257-S-01	SCALE	1/1
DSND BY: Lee Kwangseok	DRAWN BY:	CHKD BY: Park Jaehwal	APRVD BY:
	D.W.G. NO. FLT-FDL06L12-S-001A	REVISION.	00